

Wood Ladders & Folding Stairways



Wood Stepladders

Wood Pushup Ladders

Wood Single Ladders

Folding Stairways

Terms & Conditions

- Applicable taxes are extra on all prices
- Prices are subject to change without notice and will be invoiced at the price in effect at the time of order
- Volume discounts are available on most items
- Faxed or emailed order confirmations are encouraged
- Payment is required on all first-time orders before shipment
- We accept Visa, MasterCard, Debit, Cheque, or Cash
- Accounts are strictly Net 30 Days upon approved credit
- To establish an account, please ask for our credit application form and fill it out and return it
- We reserve the right to request a deposit on all larger and/or custom orders
- A 15% re-stocking charge applies to all returns
- All acrylics, custom orders, and "Clearance" items are non-returnable

Shipping

- All orders are shipped F.O.B. St. Jacobs, Ontario
- Most small shipments will be sent via Canpar and large shipments will be sent via common carrier unless otherwise specified
- Shipping charges will be added to the invoice amount unless order is shipped collect
- Shipping dates are based on prompt receipt of necessary information

Table of Contents

Product Description	Page
Terms & Conditions	2
Table of Contents	3
Wood Stepladder & Safety Feet	4
Single and Pushup Ladder	5
Ladder Accessories	6
Folding Stairway	7
Folding Stairway Features	8

Wood Stepladder & Safety Feet

Wood Stepladder

Front Rails: 1-1/4" x 2-5/8" (up to 8')
1-3/8" x 2-5/8" (10' - 14')

Rear Rails: 1-1/4" x 2-1/4" (up to 8')
1-3/8" x 2-5/8" (10' - 14')

- SD Series - Dipped w/2 Coats of Varnish
- Hemlock or Sitka Spruce Rails & Maple Rungs

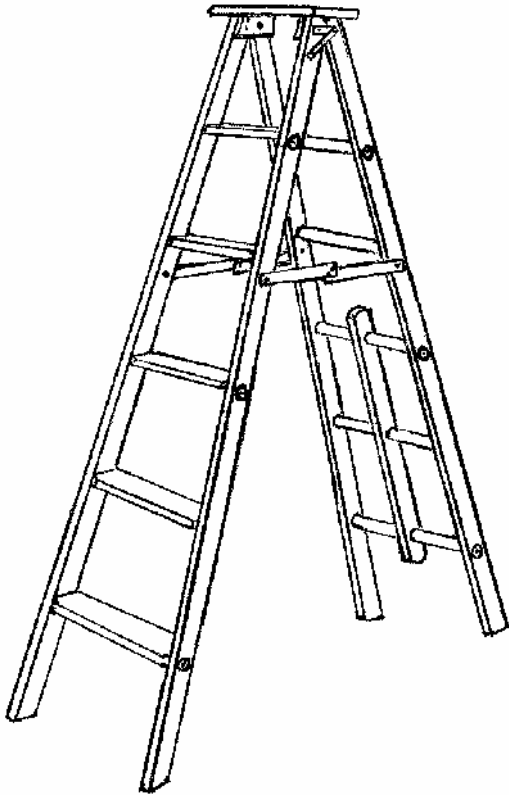

Ask about our
Mover's Ladder
- Special Order

Unfinished

Order #	Price	Size	lbs.	kg
S2	\$120.00	2'	17	8
S3	\$120.00	3'	17	8
S4	\$136.50	4'	20	9
S5	\$158.50	5'	25	11
S6	\$186.50	6'	35	16
S7	\$218.00	7'	42	19
S8	\$252.50	8'	50	23
S10	\$348.00	10'	65	30

Varnished

Order #	Price	Size	lbs.	kg
SD2	\$176.50	2'	17	8
SD3	\$176.50	3'	17	8
SD4	\$192.00	4'	20	9
SD5	\$214.00	5'	25	11
SD6	\$241.50	6'	35	16
SD7	\$277.00	7'	42	19
SD8	\$322.50	8'	50	23
SD10	\$422.50	10'	65	30

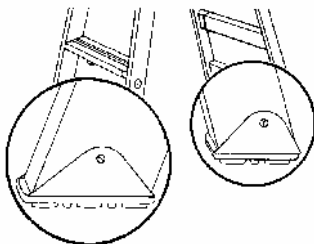

Safety Feet

Order #	Price
618-S	\$21.50 (Set of 4)

* Installation is Extra - \$21.50 per set

Kraemer Woodcraft Ltd.
11 Henry Street West, Box 510
St. Jacobs, ON NOB 2N0
Tel 519-664-2221 Fax 519-664-2105

info@kraemerwoodcraft.com
www.kraemerwoodcraft.com



Single & Pushup Wood Ladder

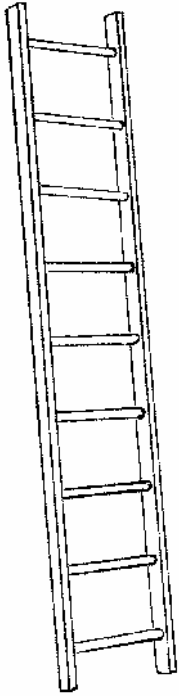

Single Wood Ladder

Rails Without Wire: 1-3/8" x 2-5/8" (8' - 18')
1-3/8" x 2-3/4" (20')

- LWD Series - Dipped w/2 Coats of Varnish
- Hemlock or Sitka Spruce Rails & Maple Rungs

Unfinished

Order #	Price	Size	lbs.	Kg.
LW6	\$69.00	6'	10	5
LW8	\$81.00	8'	15	7
LW10	\$105.50	10'	20	9

Varnished

Order #	Price	Size	lbs.	Kg.
LWD6	\$108.00	6'	10	5
LWD8	\$124.50	8'	15	7
LWD10	\$153.00	10'	20	9

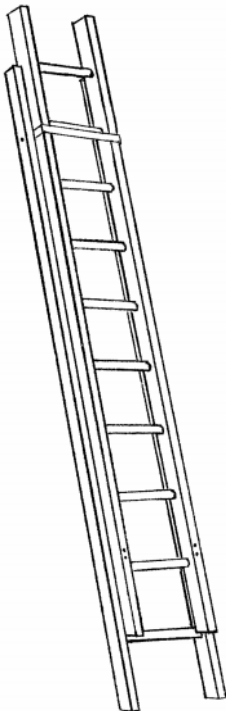

Wood Pushup Ladder

Rails Without Wire: 1-1/4" x 2-5/8" (16')
1-3/8" x 2-5/8" (20')

- Hemlock or Sitka Spruce Rails & Maple Rungs

Order #	Price	Size	lbs.	Kg.
P16	\$196.00	16'	35	16
P20	\$240.00	20'	45	20

Ladder Accessories



Safety Feet

- Set of 2

Order #
SSW

Price
\$50.00/Pair

* Installation Cost - \$21.50



Safety Feet

- Set of 2
- Can't be installed on ladders with wire

Order #
540

Price
\$31.00/Pair

* Installation Cost - \$21.50



Wheel Spur

- Set of 2

Order #
207

Price
\$21.50/Pair

* Installation Cost - \$21.50



Roof Hook

- 8" Diameter
- Clearance Item (Limited Supply)

Order #
RH

Price
\$15.00 each



Cable Hook

- 3.5" Diameter
- Clearance Item (Limited Supply)

Order #
CH

Price
\$10.00 each



Folding Roof Hook

- Clearance Item (Limited Supply)

Order #
FRH

Price
\$20.00 each

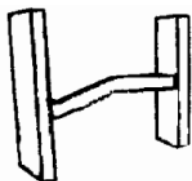

Pole Grip

- Clearance Item (Limited Supply)

Order #
PG

Price
\$10.00 each

Folding Stairway

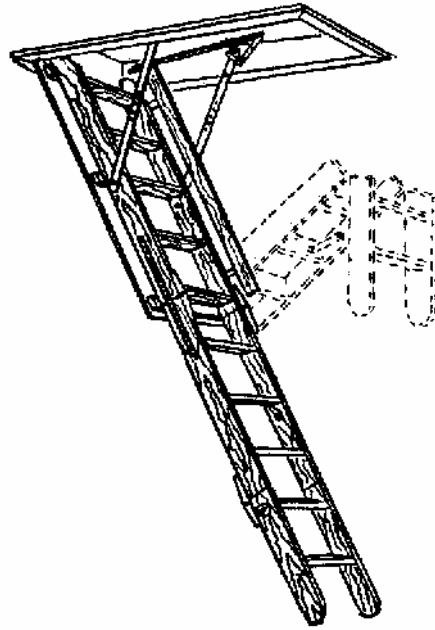

Rough Opening - 22" x 54"

Part #		Floor to Ceiling	Price	lbs.	Kg.
FS8-22	(8')	7'-6" to 8'-4"	\$354.00	55	25
FS9-22	(9')	8'-6" to 9'-3"	\$406.50	60	27
FS10-22	(10')	9'-6" to 10'-2"	\$460.50	65	30

Rough Opening - 26" x 54"

Part #		Floor to Ceiling	Price	lbs.	Kg.
FS8-26	(8')	7'-6" to 8'-4"	\$354.00	60	27
FS9-26	(9')	8'-6" to 9'-3"	\$406.50	65	30
FS10-26	(10')	9'-6" to 10'-2"	\$460.50	70	32

Rough Opening - 30" x 54"

Part #		Floor to Ceiling	Price	lbs.	Kg.
FS8-30	(8')	7'-6" to 8'-4"	\$420.50	65	30
FS9-30	(9')	8'-6" to 9'-3"	\$474.00	70	32
FS10-30	(10')	9'-6" to 10'-2"	\$527.00	75	34

Folding Stairway Features

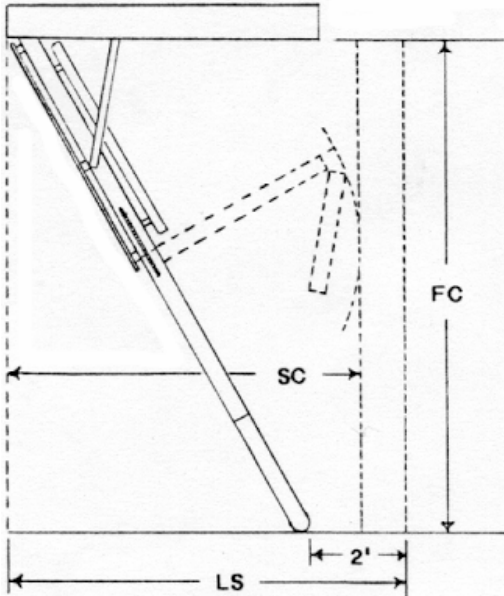

FC - Floor to Ceiling

SC - Swing Clearance

LS - Landing Space

Superior Features

- Heavy Duty Support Arms & Hardware
- Hardened Bolts in Support Arms for Longer Life
- Sturdy Wooden Side Rails - 3-1/2" x 7/8"
- Heavy Duty Wooden Steps - 3-3/4" x 7/8"
- Safety Feature - Adjustment on Support Arms for Perfect Fit Between Floor & Ceiling (Without Having to Cut Side Rails)
- Spring on Side Rail to Assist in Folding the Stairway
- Handy Dowel With Hook for Easy Pull-Down of Stairway

Model #	Capacity	Rough Opening	Floor to Ceiling	SC Max	LS for Min. FC	LS for Max. FC	Weight
FS8-22	300 lbs.	22" x 54"	7'-6" to 8'-4"	6'	7'-5"	6'-0"	55 lbs.
FS9-22	300 lbs.	22" x 54"	8'-6" to 9'-3"	6'	7'-8"	6'-4"	60 lbs.
FS10-22	300 lbs.	22" x 54"	9'-6" to 10'-2"	7'	8'-2"	6'-8"	65 lbs.
FS8-26	300 lbs.	26" x 54"	7'-6" to 8'-4"	6'	7'-5"	6'-0"	60 lbs.
FS9-26	300 lbs.	26" x 54"	8'-6" to 9'-3"	6'	7'-8"	6'-4"	65 lbs.
FS10-26	300 lbs.	26" x 54"	9'-6" to 10'-2"	7'	8'-2"	6'-8"	70 lbs.
FS8-30	300 lbs.	30" x 54"	7'-6" to 8'-4"	6'	7'-5"	6'-0"	65 lbs.
FS9-30	300 lbs.	30" x 54"	8'-6" to 9'-3"	6'	7'-8"	6'-4"	70 lbs.
FS10-30	300 lbs.	30" x 54"	9'-6" to 10'-2"	7'	8'-2"	6'-8"	75 lbs.

Kraemer Woodcraft Ltd.
11 Henry Street West, Box 510
St. Jacobs, ON NOB 2N0
Tel 519-664-2221 Fax 519-664-2105

info@kraemerwoodcraft.com
www.kraemerwoodcraft.com

